

Distributed Wind Power Generation In New Zealand's Local Electricity Networks

By:

Daniel Akinyele

New Zealand Wind Energy Conference and Exhibition

16th April, 2014

Supervised By:

Dr. Ramesh Rayudu

*School of Engineering & Computer Science,
Victoria University of Wellington*

Dr. Nirmal Nair

*Department of Electrical & Computer Engineering,
University of Auckland*

Outline

- Introduction
- Objectives
- Status of Wind Power in New Zealand
- NZ Residential Sector
- Micro-wind turbine applications
- Initial Simulation/Results
- Important Considerations
- Discussion

Introduction

- NZ has one of the best wind resources in the world.
- NZ wind energy resource is key to realizing 90% of RE by 2025.
- Wind could help minimize the effects of ‘dry years’.
(e.g. Renewable electricity decreased by 4% in 2012 due to low rainfall, while gas and coal generation are increased)
- Widespread utilization of wind energy will reduce dependence on fossil fuel

Objectives

- To explore the possibility of distributed wind generation for households
- To develop a wind-energy based microgrid, which could run both in interconnected and islanded modes
- To study the impacts of a cluster of distributed wind power generation systems on Wellington local grid

Status of Wind Energy Generation in New Zealand

- 1st Wind Farm (230kW) was commissioned in 1993
- 17 Wind farms now - with total installed capacity of 623MW from 456 WTs
- Wind electricity contributes about 5% to NZ's annual power generation

NZ's Households

- About 4.5 million people dwelling in 1.7 million households
- NZ homes consume '33%' of electricity generation. 12,845GWh out of total consumption of 38,535GWh
- National average residential energy consumption of 11,410kWh/year (BRANZ HEEP Report 2010)

Micro-Wind Turbines

- Roof-mounted
- Pole-mounted



Source:<http://phys.org/news144674984.html>



Source:http://www.pce.parliament.nz/assets/Uploads/Reports/pdf/microgen_background.pdf

Mean Annual Wind Speeds (2013)

Site	Wind Speed (m/s)
Wellington Kelburn Aws	5.2
Wellington Aero	6.8
New Plymouth Aws	5.3
Tauranga	3.8
Westport Aws	4.4
Christchurch New Brighton Aws	4.8
Dunedin city wind	4.2
Auckland Aero	4.4
Invercargill Aero Aws	4.4
Auckland Mangere Ews	4.2

Household Electricity Demand/Energy Configurations

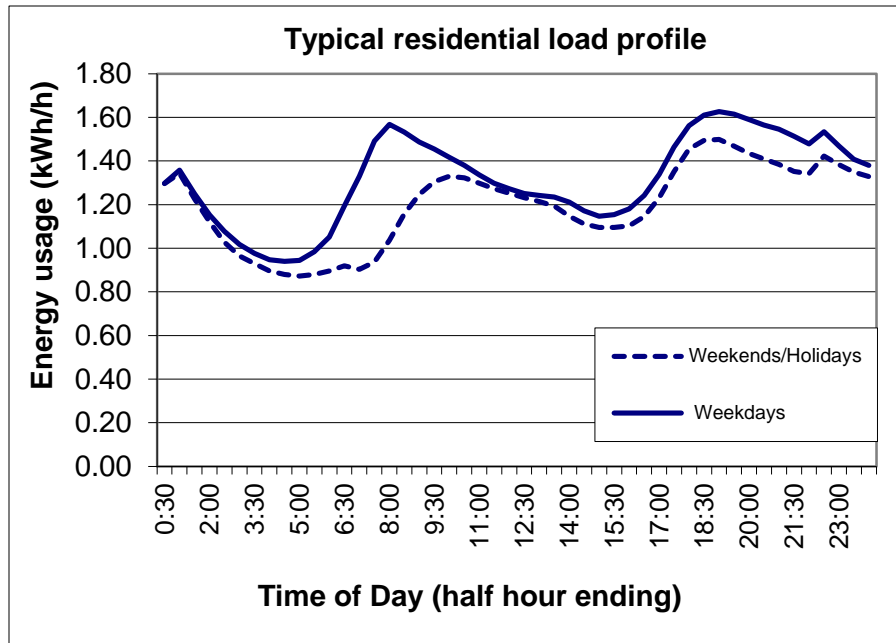

Typical Residential Demand

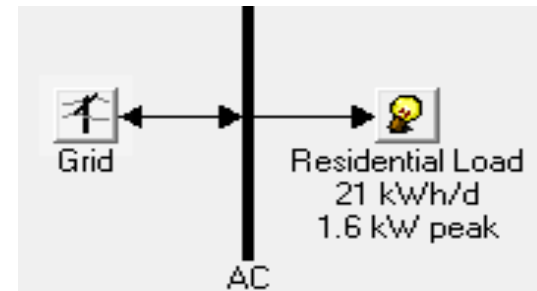

Grid Only

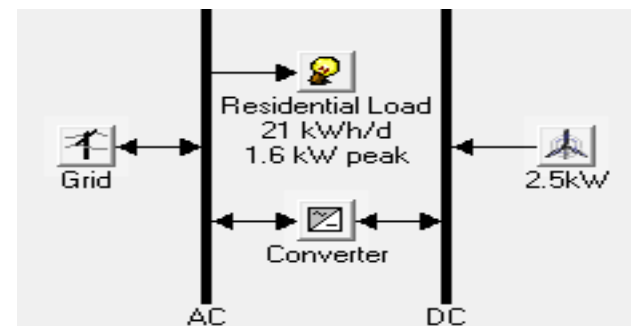

Grid + Wind Gen.

Total Annual Household Energy Consumption (All Fuels)

S/No.	Location	Av. Energy Use (kWh/occupied dwelling /year)
1	Auckland	10, 660
2	Hamilton/Tauranga	10, 750
3	Wellington	10, 860
4	Christchurch	11, 010
5	Dunedin/Invercargill	14, 580
6	National	11, 410

Source: BRANZ HEEP report 2010

Total Annual Household Energy Consumption (Electricity only)

S/No.	Location	Av. Electricity (kWh/occupied dwelling/year)
1	Auckland	7,970
2	Hamilton/Tauranga	7,270
3	Wellington	7,840
4	Christchurch	8,710
5	Dunedin/Invercargill	10,610
6	National	7,800

Source: BRANZ HEEP report 2010

Gas consumption (space heating, water heating and cooking)

Location	Gas (kWh)	Combustion CO2 Emissions factor (0.1907kg/kWh) <small>MBIE</small>	Gas Price /kWh
Auckland	2,690	512.98	NZ 14.25 cents (USD 11.83 cents) <small>MBIE</small>
Hamilton/Tauranga	3,480	663.64	
Wellington	3,020	575.91	
Christchurch	2,300	438.61	
Dunedin/Invercargill	3,970	757.08	

Cost/Tariff/Buy back Rate

- \$10,000 - \$15,000 per KW of rated capacity (EECA energywise)
- 2.5KW Pole-mounted WT costs between \$26, 000 and \$28, 000 (Current Generation Ltd).
 - Inverter @ \$3000
 - 2.5kW WT @ \$18,000
- Tariff of NZ 28 cents is used

Retailer	Buy back Rate
Contact Energy	NZ 17.285 cents/kWh + GST (up to 10kW DG). 7.0 cents for more than 10kW.
Meridian Energy	25 cents/kWh for the 1 st 5kWh. 10 cents/kWh for further export same day. + GST
Trust Power	7.0 cents / kWh + GST (for up to 10kW)
Genesis	4 -7 cents /kWh (North Island Only)
Mercury Energy	Any units used over what you import will be bought back at 3.5 cents/kWh (Auck. & Christchurch only)

Source: PowerSmart Solar Electricity

Initial Simulation Results

	Wellington Kelburn	Wellington Aero	Dunedin	Tauranga	Christchurch	Auckland Aero
Av. Speed (m/s)	5.168	6.777	4.234	3.751	4.799	4.409
Demand (kWh/yr)	7,840	7,840	10,610	7,270	8,710	7,970
Grid Price (USD/kWh)	0.232	0.232	0.232	0.232	0.232	0.232
Grid Emissions (kg/yr)	1,177	1,177	1,593	1,090	1,309	1,194
Turbine Rating (kW)	2.5	2.5	2.5	2.5	2.5	2.5
Energy Yield (kWh/yr)	5,286	9,125	3,497	3,588	3,489	3,518
Micro-Wind Fraction (%)	52	71	30	40	35	38
Import (kWh/yr)	4,944	3,723	8,159	5,292	6,480	5,851
Export (kWh/yr)	1,676	4,043	559	1,082	771	912
Initial Capital (USD)	23,076	23,408	22,910	22,910	22,910	22,910
COE (USD/kWh)	0.352	0.277	0.344	0.401	0.370	0.385
Emission Factor	0.15	0.15	0.15	0.15	0.15	0.15
Emissions (kg/yr)	490	-48	1,140	632	856	741

WT Energy Yield vs. Demand

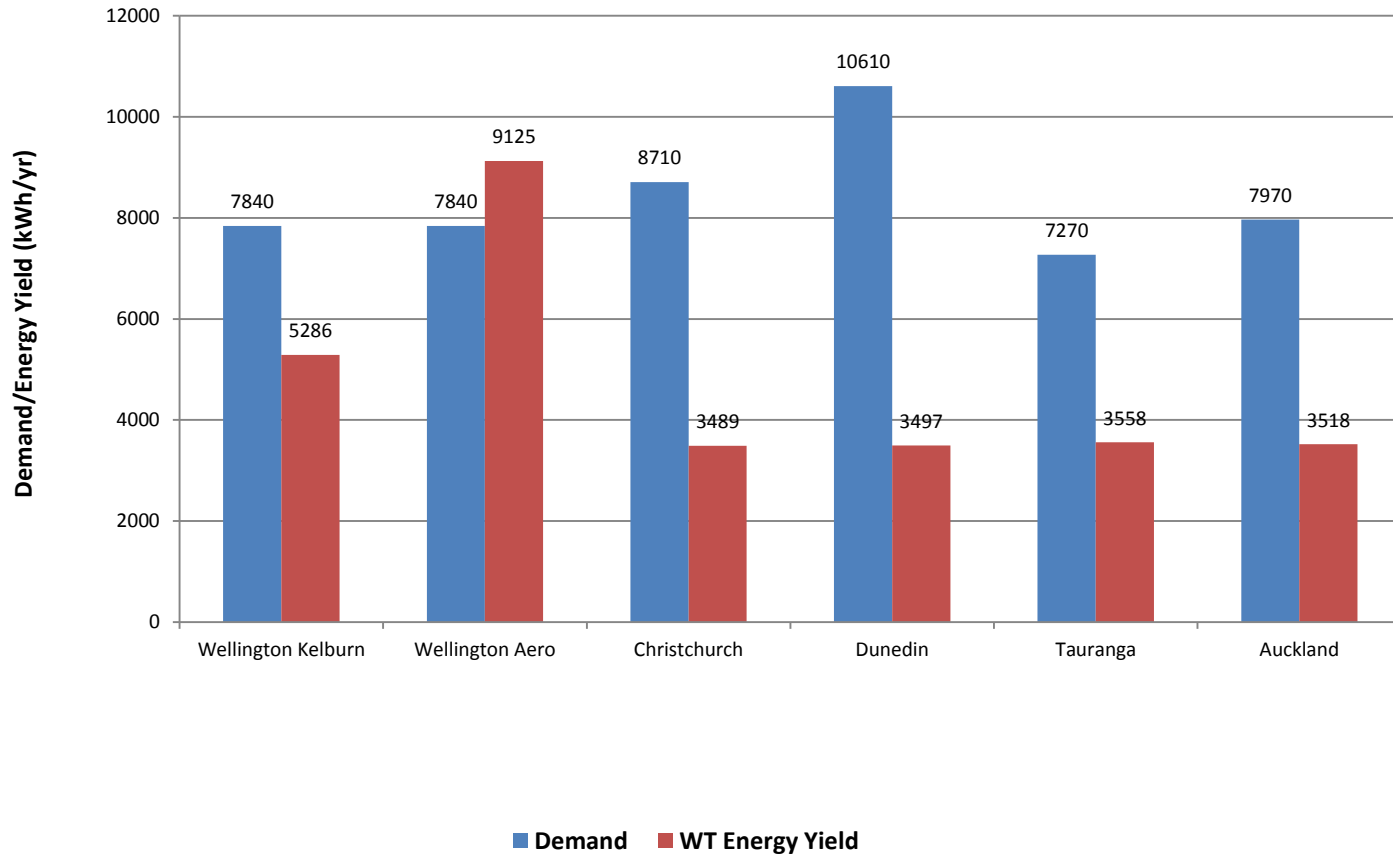

Import vs. Export Electricity

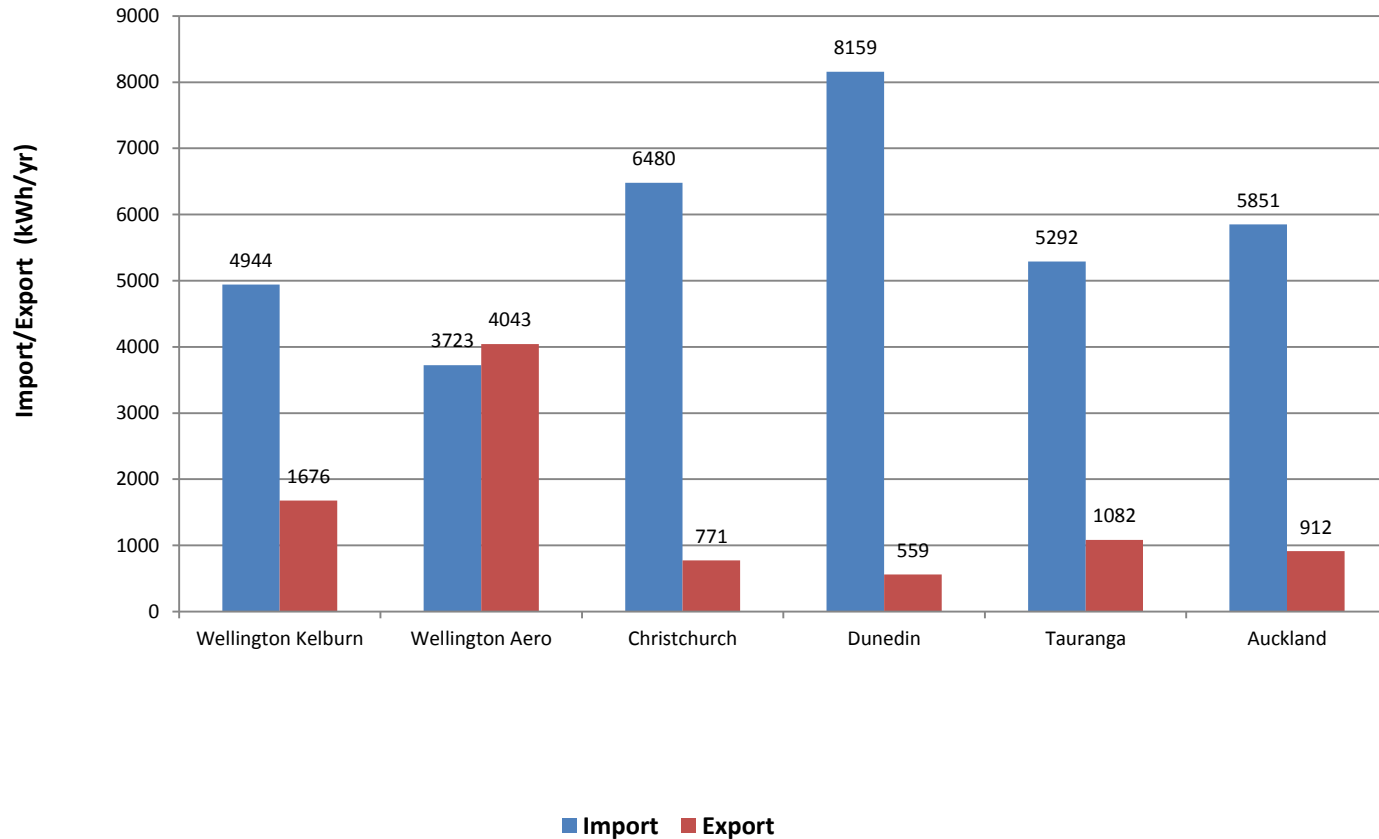

Cost of Energy vs. Tariff

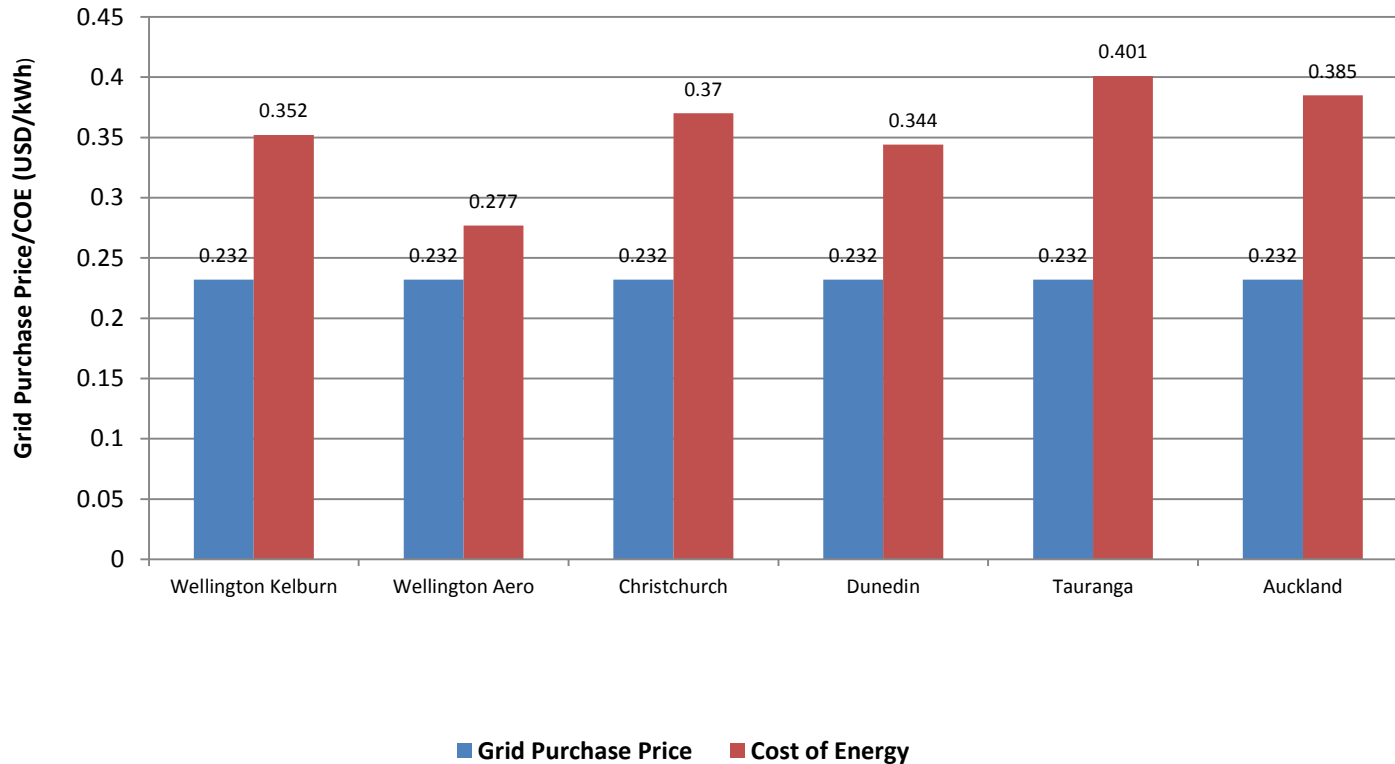

Emissions

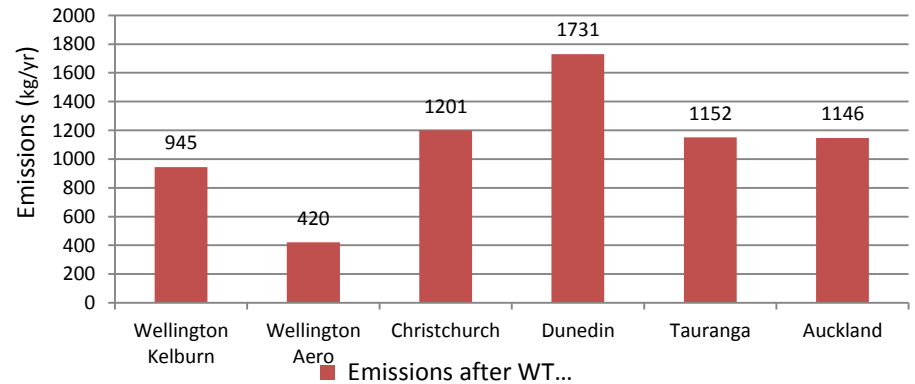
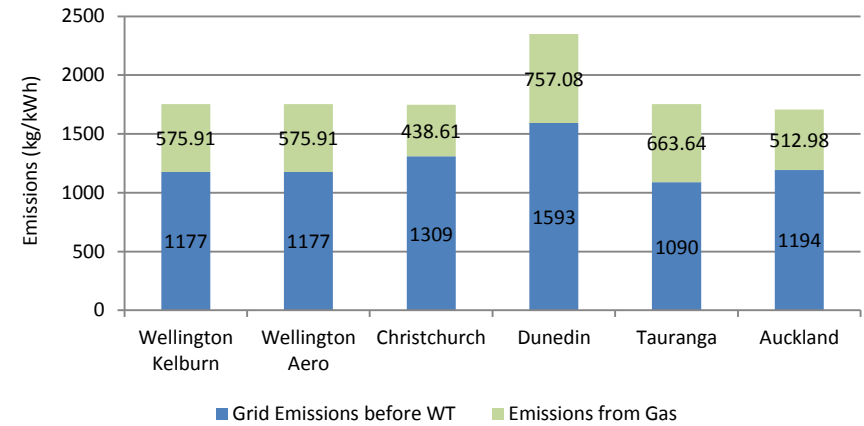
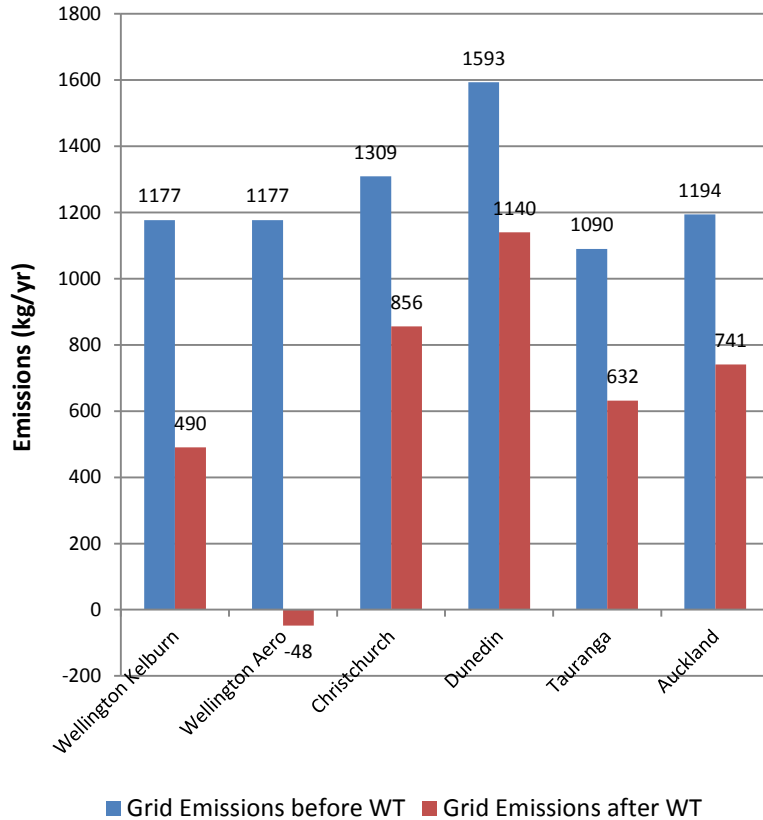

Important Considerations

- Cost
- Location
- Noise level

Sources: http://www.pce.parliament.nz/assets/Uploads/Reports/pdf/microgen_background.pdf
Small Wind turbines –(www.energywise.govt.nz)

Discussion

- Micro-wind generation can meet a part of a household electricity demands
- It also has a potential to reduce emissions
- Identification of suitable sites, e.g. locations with strong and consistent wind is crucial
- The use of energy efficient appliances is also important for reducing household electricity consumption
- This research still continues and micro- wind electricity will also be considered for schools, community halls, small rural communities, remote homes, farms etc.

References

1. Electricity Supply and Wind Generation – NZWEA (www.windenergy.org.nz)
2. Energy Consumption, Ministry of Business, Innovation and Employment Available:
<<http://www.med.govt.nz/sectors-industries/energy/energy-modelling/publications/energy-in-new-zealand-2013>>
3. Household Energy Demand in NW by John Polkinghorne, The Energy Conference 2013.
Available:
<http://www.theenergyconference.org.nz/uploads/98897/files/Presentations/John_Polkinghorne.pdf>
4. Microgeneration Potential in New Zealand by East Harbour Management Service.
Available:
<http://www.pce.parliament.nz/assets/Uploads/Reports/pdf/microgen_background.pdf>
5. Small Wind turbines –(www.energywise.govt.nz)
6. An Electricity Emission factor <http://www.mfe.govt.nz/publications/climate/electricity-emissions-factor-reports/electricity-factor-aug03.pdf>

THANK YOU

Yield vs. Demand

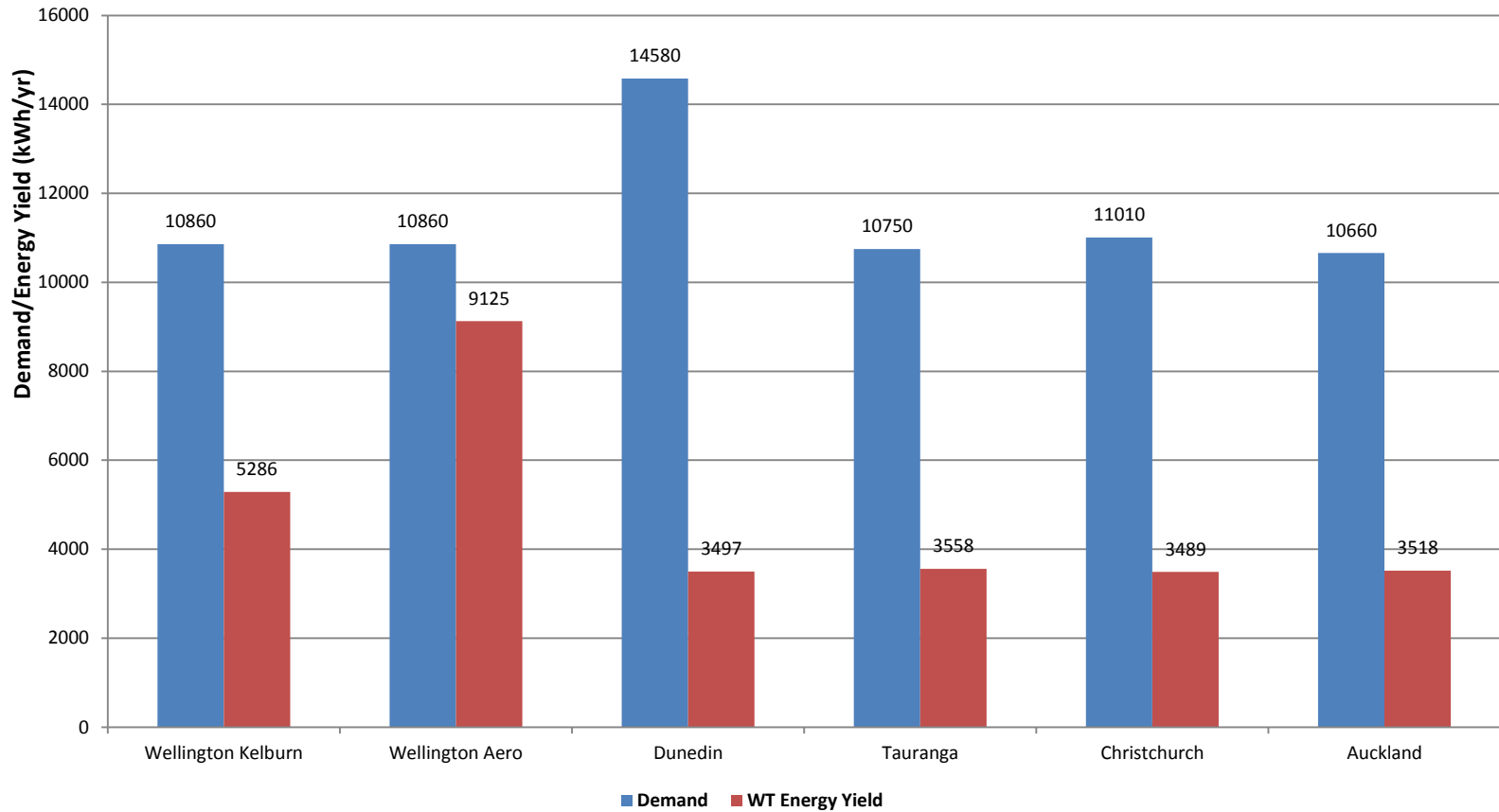

Import vs. Export

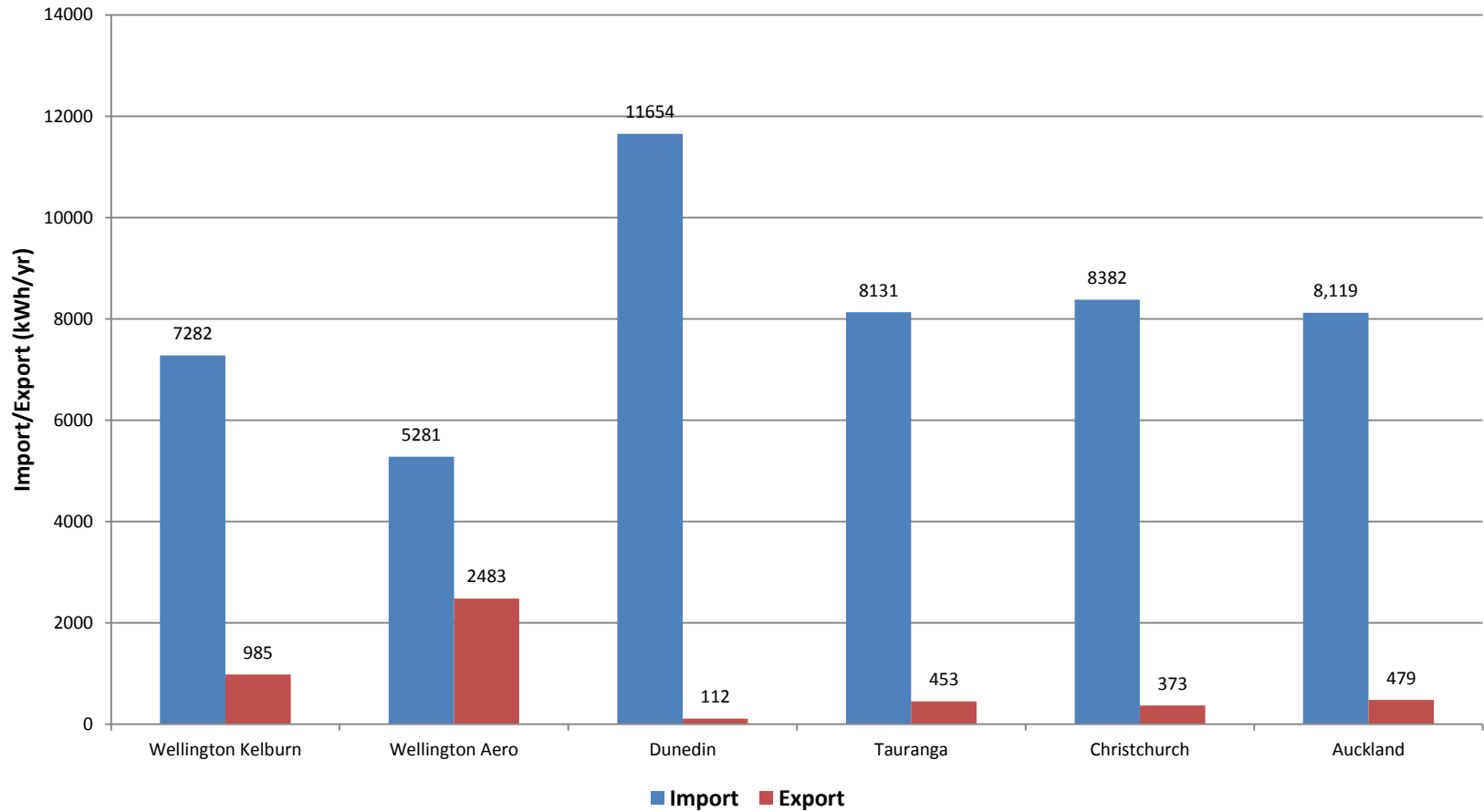

Tariff vs. COE

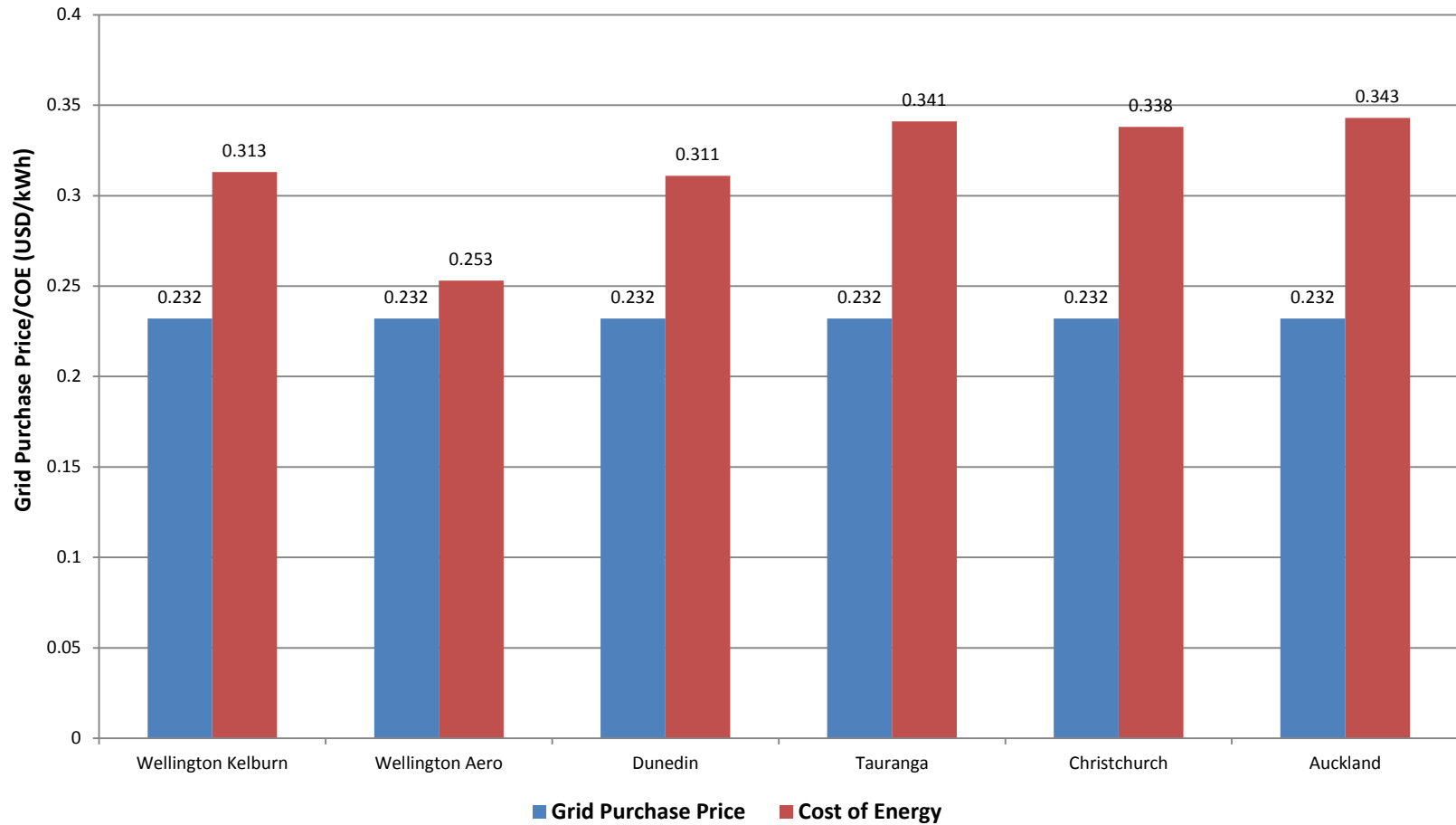

Emissions

